

July, 2017

Basic Electricity for Solar Understanding

Click image to enlarge pictures below

This is the place for a simplified discussion and any tutorial training on principles of electricity that are important for understanding solar systems. Many people learned about electricity in their youth, but have long since forgotten the basics. In the age of solar systems, suddenly there is a need for increased understanding, since there is now a practical application. There is an attempt here to minimize the concepts and make it more helpful to non-native speakers of English.

The Concept of Energy

Energy is simply defined as the **ability** or the **capacity to do work**. And there are many forms of energy including nuclear energy, wind energy, water (hydro) energy, and burning coal and fossil fuels. However, we are more interested here in solar energy: the energy freely given to the earth daily by our sun. We often speak of "renewable" energy sources like wind and hydro, however they are basically transformations of solar energy at the origin. The transport to the top of the mountain for water is actually by solar energy converted to "stored" energy as the water flows down the mountain. The winds of the earth are created by unequal solar radiation upon the surface of the earth.

There is **kinetic** energy when things are in motion, or some activity while doing work at the moment, such as an electric light glowing. And there is **potential** energy, which is really stored energy. Potential energy resides in an inactive bolder sitting on the top of a mountain, that then gets released when gravity takes over and it falls due to an earthquake. There is potential or stored energy when we translate electric energy into the chemicals of a battery, where such electrical energy can easily be released later by an electric circuit. The latter is what solar energy is all about: Converting the energy from the sun into electricity, storing that energy for later use typically by employing batteries, and then the release of that energy back to electricity when we want to do useful work. We might want to illuminate a room with lights, boil water with a heating element, refrigerate an important vaccine in a refrigerator, or run a notebook computer to engage in Bible Translation and other Language Development tasks.

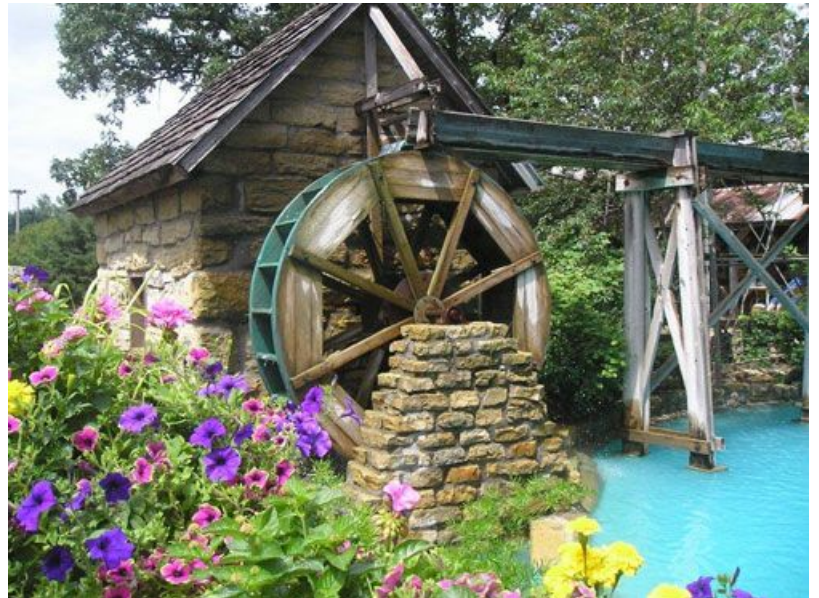

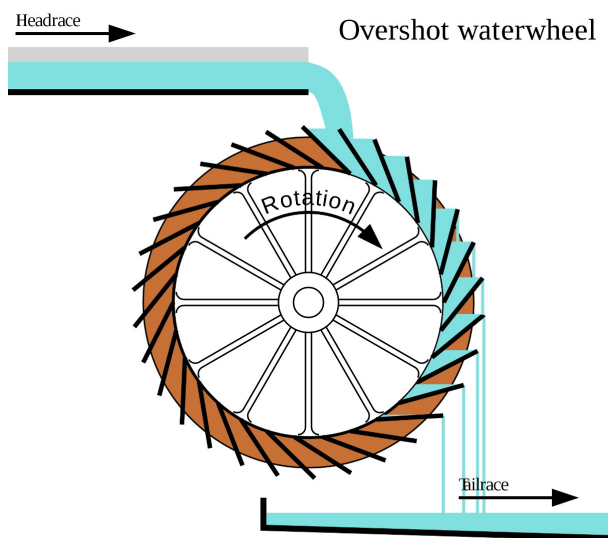

Most of us live near rivers where energy in the form of flowing water is readily seen. In the olden days often people often redirected water supplies to engage water-wheels that converted some of the freely flowing river water over a wheel that turned a rotating shaft to do useful work. This might be grinding wheat into flour. These places were called mills. Once the free energy of the river was harnessed and transformed into a rotating shaft, this shaft could then be connected to machines to do other tasks. So one can hopefully see that doing work requires energy; energy is really doing work.

When it comes to solar systems, we usually talk about storing energy inside batteries to do useful things like power lights in our houses. There is an analogy (a similar picture) here with the source of the river and its water energy stored, for example, in a reservoir at the top of some mountain, and then we pipe the water to a water-wheel. In the electrical analogy with water, we have wires that direct electrical energy from a storage source, usually a battery, to something that does useful work, like a light-bulb.

Consider this simple picture of an electrical circuit to the lower-right. The energy stored in the battery is directed to the light-bulb and if the circuit is "complete" where the energy travels in an unbroken circle, then the light, is "on" and glowing. If there is a break in the circuit (circle of wires) then the light is turned "off" and no longer glowing. One could break the circuit by cutting it with scissors, but then it would be hard to reconnect the circuit at a desirable time. So we introduce a "switch" a device that is designed to break and re-connect the wires thousand of times without wearing out.

But the main points are that once solar energy is converted to stored electrical energy, then there are many useful things we can do with that energy and we can control it as we would like.

You may be wondering about the "circle" here in the electrical circuit. Isn't this different than the water analogy? Well, yes, and no. The water analogy does indeed fail us at times in understanding electrical circuits, but with hydro power (above) consider this. The water from the river, once it has done it's work at the mill eventually flows to the ocean. The sun and its solar radiation, cause the water to transform to vapor and form clouds while also causing the winds that blow the clouds and their water vapor to the mountains. Then it rains, and fills lakes and streams that then create the river that flows past the mill house. The "circle" is now complete. In one sense there is a complete "water circuit" related to water and rivers doing work. And if I could somehow block the water flow by using a dam of some kind, then the water would not flow, and the mill would cease its ability to do work. In fact when the mill owner above wishes to stop the mill wheel from turning, they simply block the "sluice" or pipe that directs the water. it could simply be a sliding door at the start of the pipe. A kind of switch.

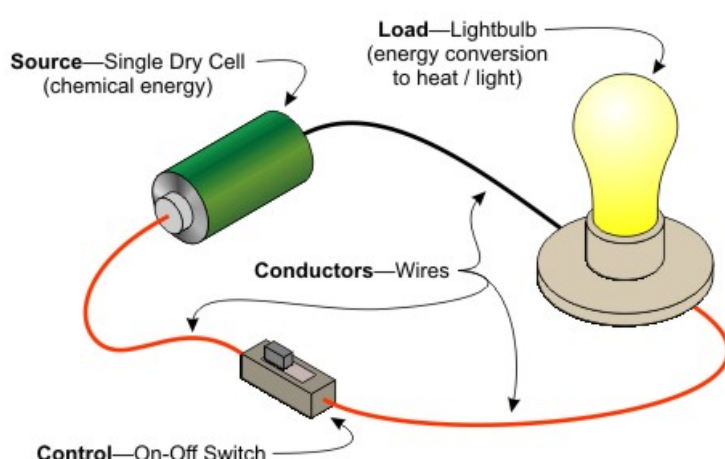

Looking at **energy and solar systems**: The solar panel is a device that converts the solar energy coming to earth into electrical energy. The first solar panels were invented in the late 19th century, and have become better and better over the years, in terms of their ability to capture more solar radiation (energy) and convert to larger amounts of electrical energy. Even today, most of the sun's solar energy is not captured and warms the ground and panel instead. Also related to solar systems is the concept of "energy storage" where the captured energy from the sun flows through wires and charges up a battery of some kind. Later, when we most want to work, for example in the evening when there is no sunshine, we can apply the stored energy found in the batteries to do useful work later.

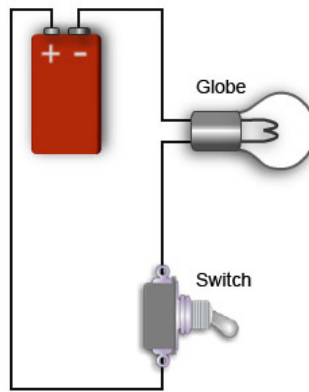

Figure 1: Electrical

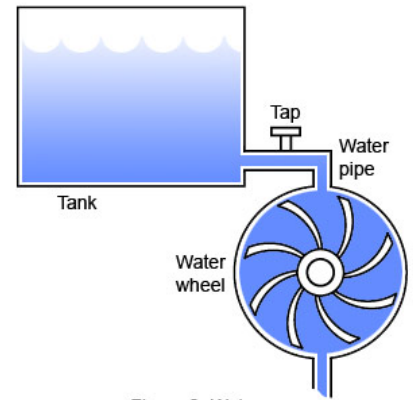
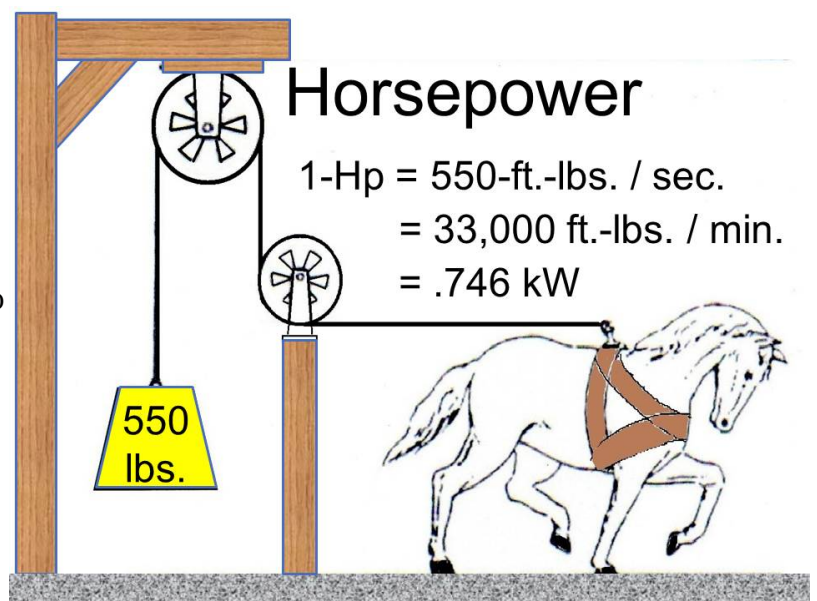

Figure 2: Water

Power in Comparison with Energy (Work)

There is a difference between **Power** which is the ability or rate of doing work, instead of talking about **Energy**, which is the **work performed** itself, or the **potential to do work**, as in the case of a battery which might store energy. When we fill up a battery with electrical energy, we can expect a certain amount of work to be performed later, by the same battery. The "work" we want performed could be to run a motor that pumps water that fills an irrigation ditch for our food crops. Let's see if we can make any practical illustrations about this.

You have probably heard the term "horsepower" and indeed in the olden days, horses were commonly in use for performing work duties. So the "power" of an average horse was eventually made standard as to how much work could be performed for a unit of time, say a second of labor, or a minute of labor. So "One Horsepower" was equivalent to the amount of energy used by the horse over a period to time, to get a standard amount of work done. Consider this picture.



Here we see one horse, lifting a weight a given distance for a minute or a second of work. What happens if I hitch two horses in this diagram? I could expect the weight to move twice as far in a second, or I can lift twice as much weight for the same distance as before. Power defines how much work can be performed for a given amount of time. This is often expressed in a formula:

$$\text{Work} = \text{Power} \times \text{Time} \quad \text{or} \quad W = P \times T$$

So again, if I double the power, I can get twice as much work done, for the same amount of time.



So how does all this relate to solar systems? Well probably you have looked at solar panels, and noted that they come in different sizes and also different prices. Their ability to do work is also measured in Power units called watts. In this case, and with electricity in general, we don't talk about horses as units, but rather we talk about **Watts (W)** in terms of the ability for the solar panel to do useful work. Note that in the horse diagram above, the horsepower can also be measured in Watts: 746 Watts to be exact. For our village setting, work could mean capturing the sun's energy, and converting it to electricity and storing it inside a battery of a known capacity. It could be that it takes one hour to fully

charge a given battery with a solar panel of 50 watts, Then if we increase the size of the solar panel to 100 watts, then we would expect the battery to fill up with energy, in 1/2 the time as before. In this case 30 minutes. I get the same amount of work done (filling the battery) but in one-half the time. This is similar to the one horse above having a partner (two horses) and then they lift the same weight the same distance, but in 1/2 the time as before. One could easily replace the horse above with a motor that then lifted the weight; the motor would spin faster with the larger solar panel connected to it and get the same amount of work done, but in one half the time.

Concepts Unique to Electricity

So the reader now understands better the relationship and difference between energy and power, but often when encountering a solar system there are more new concepts to address such as voltage and current. We face the challenge of understanding when say we see a "12 Volt" car battery, the ability to deliver "200 Amps current". What are these units and how do I usefully interpret their meaning?

For electrical circuits, including those found in automobiles and houses, voltage and current are parts of the whole called "Power". You already know about Power above as the "rate of doing work". In other words how fast can I work. For electricity power gets divided out into two related parts: voltage and current. In this section we hope to show the relationships of these two concepts and to power.

Electricity is all about the flow of electrons around a circuit. The "push" behind the movement of these electrons is called "electromotive force" or the **Voltage**. The rate or the number of electrons moving around is the **Current**.

Current relates

well to the water analogy (picture) above because water has a current as it flows down a mountain. However, the "push" behind the water is a bit more abstract. For that we need to get away from the river concept (we don't normally get to alter gravity), and move to pipes and pumps where the pump can be stronger or weaker.

So consider this diagram on the right and **please ignore all the fancy notes**. If the pump (voltage) is

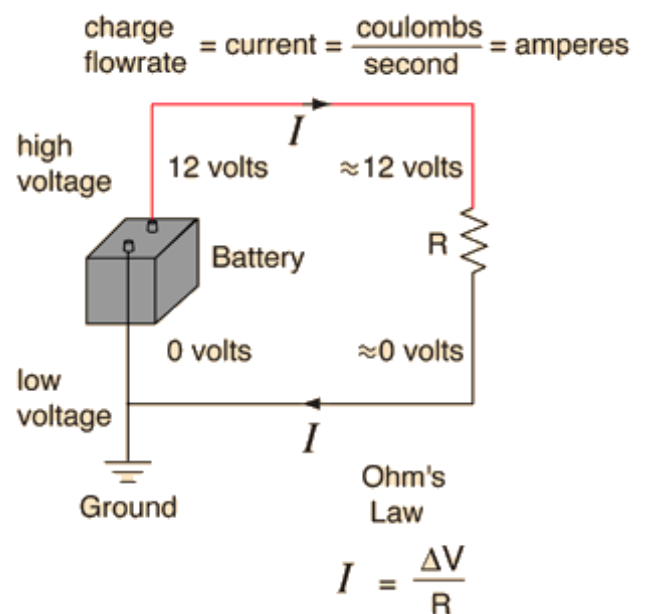
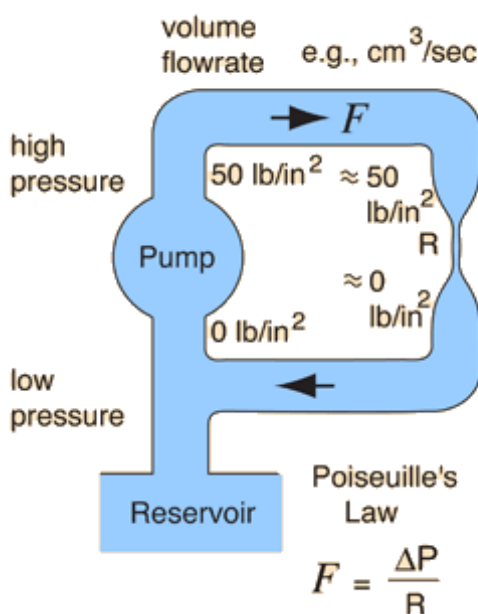

twice and strong, then we could reasonably expect the current flow to be twice as fast. We would say the pump or the battery is more "powerful" and we would be correct. It would have twice the power or the **ability to do work** (see above) because we increased the "push" or the voltage by twice the amount as before. So by raising the voltage, we have raised the power of the system.

Some readers will no doubt want a discussion on that part of the diagram that represents "resistance" or really the "load" of the circuit. For the less advanced reader, just think that the "necked down" part of the pipe, or the "resistor" in the electrical circuit would be where the light bulb was in our other diagrams. The "R" or "neck" represents the object doing work, like the motor, light, heating coil, fan, or the smart-phone battery we want to recharge. We are purposefully avoiding the discussion on Ohm's Law here, but you can read about that if you want a more "advanced topic" below in the reference section.

More importantly for solar applications:

Power = Voltage x Current or $P = V \times C$

Which is to say that if you want to know the power of something, you need to know its voltage and current. For electricity, power is measured in **Watts (W)**. Voltage is measured in **Volts (V)** and Current is measured in Amperage or **Amps (A)** for short.

So for a solar panel marked as 100 Watts, and we know that it is a "12 volt" solar panel, then we can expect by the formula above that it would produce 100 watts divided by 12 volts = 8.33 amps. This of course is what one would expect in full sunlight and no cloud cover in the sky. The full power output of the 100 watt panel would be close to 100 watts of power.

We tried to make things simple above. Some of the confusion in all this comes from people talking about the measurement units, instead of the overall concept. So Watts (a unit of power) is often expressed into the basic units of current and units of voltage as well. Therefore the formula above is often merely expressed:

Watts = Volts x Amps or $W = V \times A$ or $W = VA$

This is all the same thing, but expressed in the units of measurement.

Making this practical: You are in the village and system that was once working well, is **not performing all that well today**. The solar batteries don't seem to be charging up as fast as they used to on a sunny day. You take your "current meter" (see [Tools](#) section) and you wait for a full sunny day, and you measure the current coming down the wire from the roof-top solar panel to the solar controller and battery box (see other sections for explanations of a solar system). But with the 12 volt, 100 watt solar panel you know about, you only measure 4 Amps, instead of 8 Amps of current. The solar panel is not working as hard as it should be to deliver energy to the system. What is wrong? Probably the front solar panel glass is covered with dust and grime and debris from village life. Someone should climb on top of the roof and possibly wash the solar panels. Because you understood the formula above, you could determine that the panel was in trouble without having to actually climb up on the roof to investigate. You could also determine that the problem was the solar panel, and not the batteries. Sometimes it's the batteries that are at fault, but not in this case.

Basic Battery Knowledge

The major point for this section is that batteries store electrical energy in Watt-Hours, whereas we often want to talk about how "Powerful" the battery is. It's not about Power with a battery; it's about how much energy is in there to do useful work.

Think of the battery in your solar setup. It could be a Lead-Acid battery similar to what is found in an automobile or it could be a new Lithium Iron Phosphate battery (See Battery section). They all have a

similar purpose in that they are like a bucket or a reservoir, or a container that holds energy. The unit of energy can be expressed in Joules, or in our case is often expressed at **Watt-Hours (Wh)** or energy. So just as a container might hold 1000 liters of water, a battery might hold 1200 Wh of energy, such as this large Prismatic type battery shown here on the right.

So, let's go back to our light-bulb circuit above. If the light-bulb glows and consumes 5 watts (It's the nice LED variety) and brightly illuminates your kitchen table, and if it runs for 4 hours... then the energy (work performed) that night was 5 watts, burning for 4 hours, or $5 \times 4 = 20$ Wh of energy consumed. This amount of energy was transferred from the battery.

If you turn on another light for four hours, then add another 20 Wh of energy consumed. But what about your Codan Radio that runs off your 12 volts solar system? Each morning you talk to the capitol city in your country, which is very far away, but the radio consumes 200 watts! However, you only have a conversation for 15 minutes. That's 1/4 of an hours. So the energy consumed from your battery, was $200 \text{ watts} \times 1/4 \text{ hr} = 50$ Wh.

So now a typical day you spent $20+20+50$ Wh to do lights at night and a radio work by day. That's 90 Wh or energy. Do you have that amount in your solar system? It depends upon the size of your batteries at this point. If you have an old-style and fragile Lead-Acid battery (see Battery section) and it's a standard automotive 12 V, 100 Ah size, then you might think that a fully charged battery contains $12 \times 100 = 1200$ Wh (Remember $W = V \times A$). But you would only be partially correct. Lead-Acid can only really release 30% of their stored energy, otherwise you hurt the battery and it must be replaced quickly. So 30% of 1200 Wh, means you only really have 360 Wh of **useable** stored energy.

(Note: LFP batteries might appear to be more expensive at first, but because they are lighter, last longer (10 years or more) and can use 80% of their available stored energy... they might actually be less expensive in the long run)

Back to our lights and Codan radio example, we have already used 90 Wh of energy in our daily allotment, and we only had a maximum of 360 Wh to use each day. Now if we add a computer into the mix, we may be in trouble, depending upon whether you have an older-style computer, or the new kind as mentioned in this Handbook. With one computer you might only be able to work 2 hrs a day; with the other kind, 10 hrs each day. it makes a huge difference.

Quick but *Deeper Understanding* (References)

It's hard to imagine someone setting up a solar system without some fundamental knowledge of the science of electricity. However, the concepts above are meant to make things practical and simple. if you want a **deeper knowledge** of electricity and circuits created to do real work, then these references will help with the basics... yet they are more than you need to know to maintain a working solar system.

For those of you who are fluent in English and come from a well-educated background then there are many on-line lesson plans, and most go far deeper into the details about working systems than one would really need for understanding a solar system. But if you want a deep refresher course, one where the materials are in .PDF form and can be downloaded for your own purposes, then consider the [Lessons in Electric Circuits](#), web-site by **Tony R. Kuphaldt**

Another great resource on the web appears to be the [School for Champions - Basic Electricity](#), web-site by **Ron Kurtus**. We prefer the diagrams at this one, plus there are some quizzes on the material learned.

No doubt others can introduce further web-sites to look through in this space. Feel free to contribute if

you know of more appropriate resources out there, but keep in my that we are interested in freely available materials that can be easily copied in terms of their license agreements, since anyone can print these SCOS Handbook pages at will.